

KITCHEN DESIGNS
BY  **AGT**

PREFACE

AGT is a brand that brings wood together with technology and leads the sector with its innovative perspective by closely following all world trends.

Defining your style is much easier with AGT.

In this catalog, you will find different color and surface options designed with AGT panels, as well as kitchen alternatives combined with AGT profiles in the same space.

All of the products in this catalog are manufactured and designed by AGT.



SENSITIVE TO NATURE PRODUCTS THAT RESPECT THE FUTURE

At AGT, we know the value of what nature offers us, and we prioritize our concern for a sustainable life and a green future above all else. For this, we think about tomorrow today with our environmentally friendly products.







YOUR DREAM KITCHENS

Kitchens are the place where we spend the most time at home, not only for cooking, but also for pleasant meals and family gatherings. For this reason, most of us always think of large areas. However, rather than the width of the space, it is important to be able to use the kitchen ergonomically and to combine this ergonomics with colors and textures that you can use for a long time without getting bored.

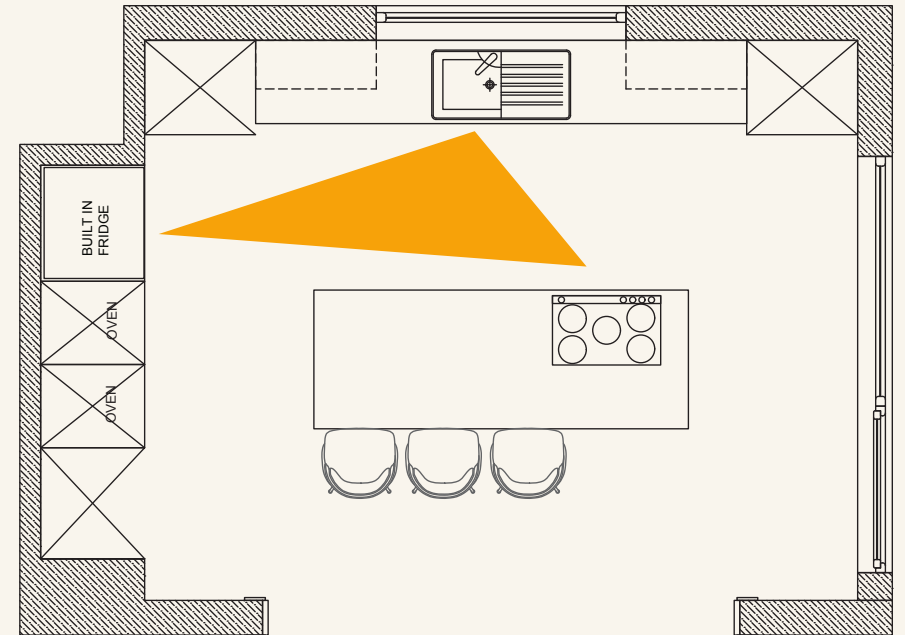
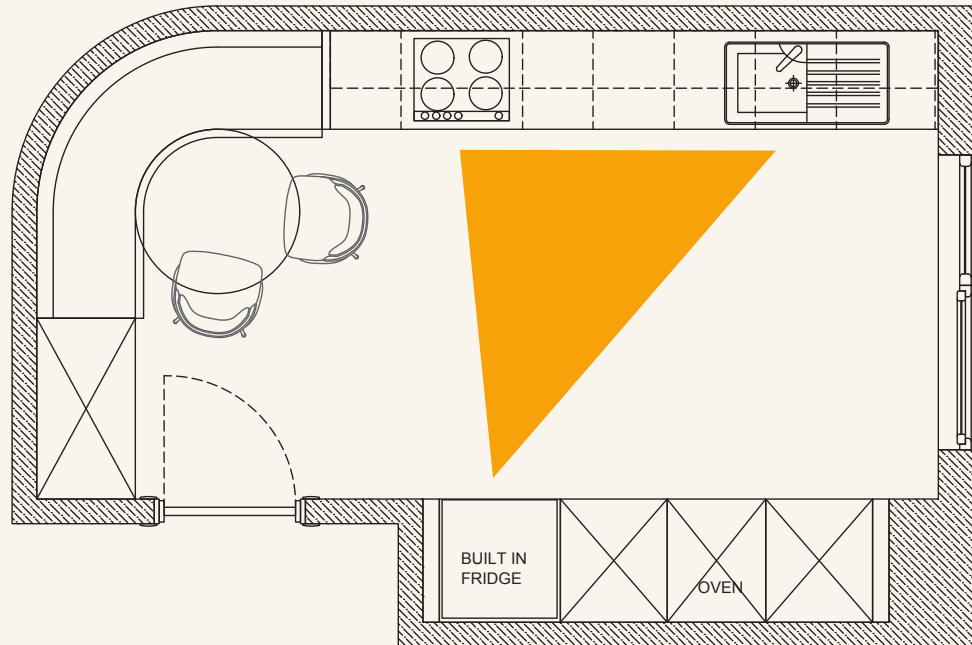
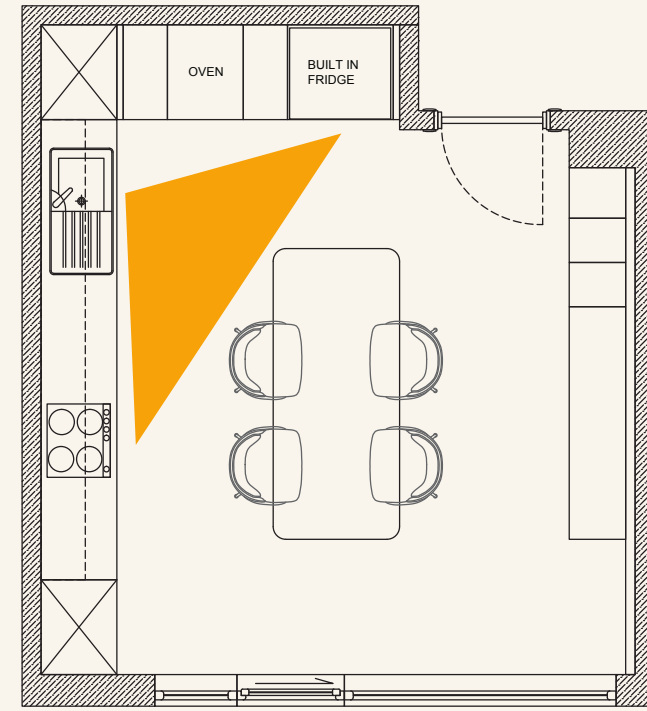
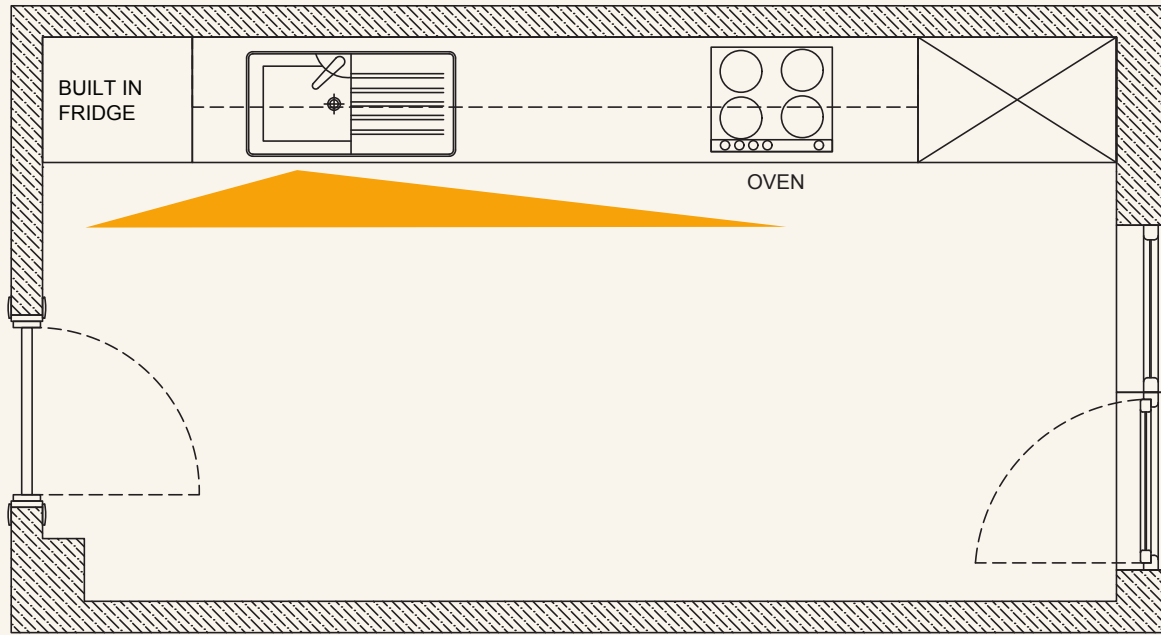

In kitchen designs, besides the color and texture of the doors, functionality is very important.

For those who use the kitchen, it is useful to adhere to the kitchen work triangle so that they can do much more work in less time. The kitchen work triangle allows a person who wants to cook to reach the sink first for the washing process, after taking the ingredients from the refrigerator, and after completing the preparation stages, the area used for cooking is at shorter distances.

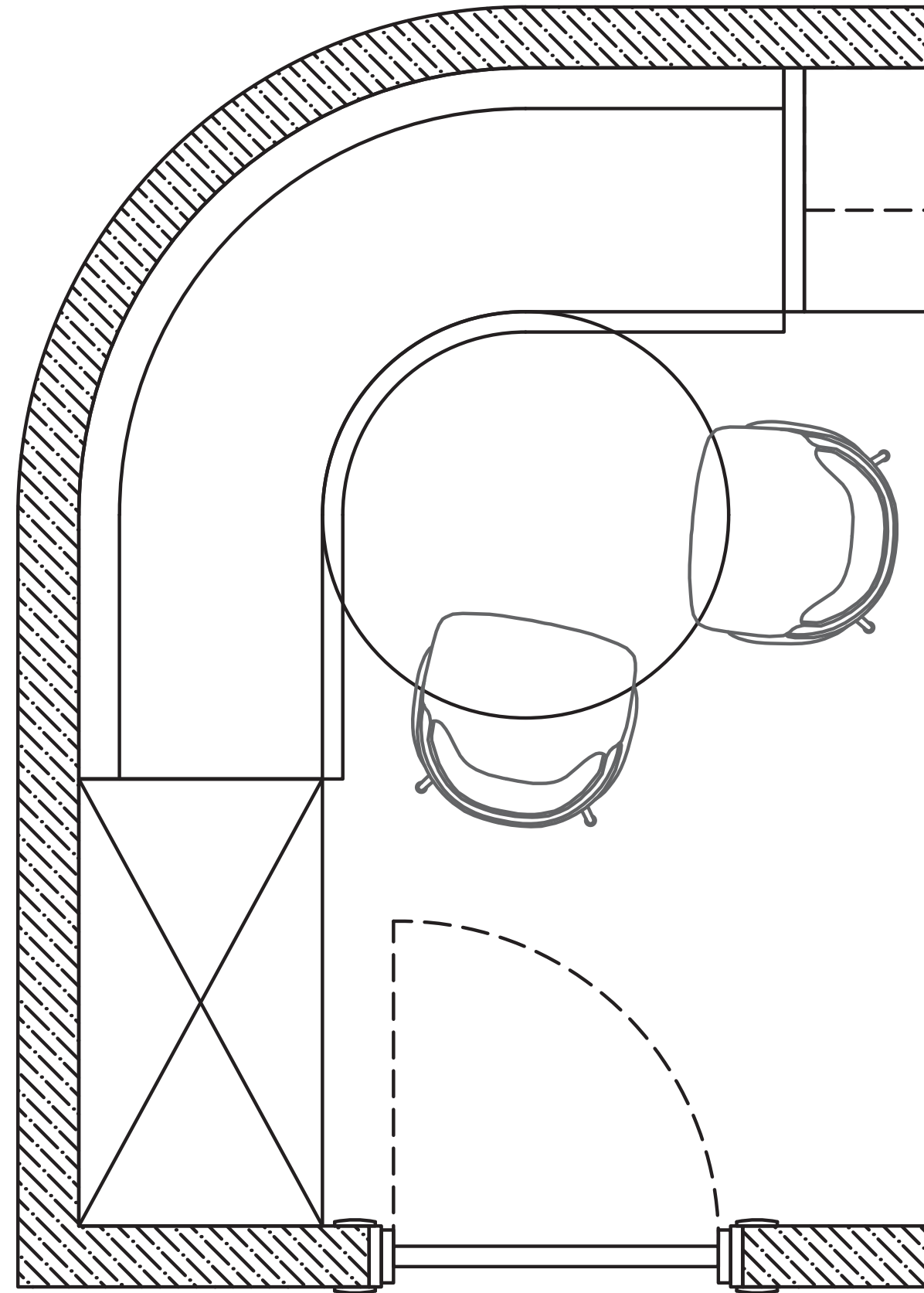





CLASSIC KITCHEN DESIGNS





One-Wall Kitchen 1

The perfect combination of AGT profiles and the green tones in the Supramat collection!

Instead of different color combinations in your kitchens, we can achieve simple designs by capturing tone-on-tone harmonies with different shades of the same color.



Multi Purpose Profile

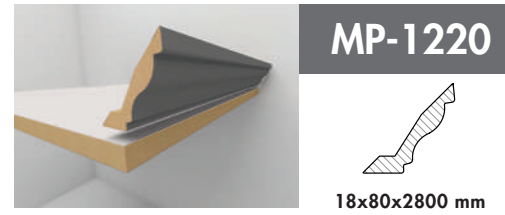

4 mm Glass Profile

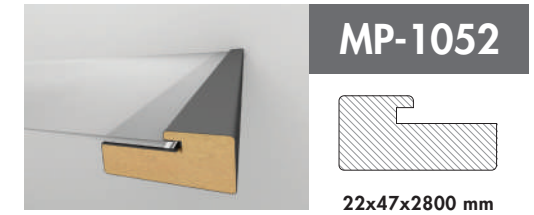





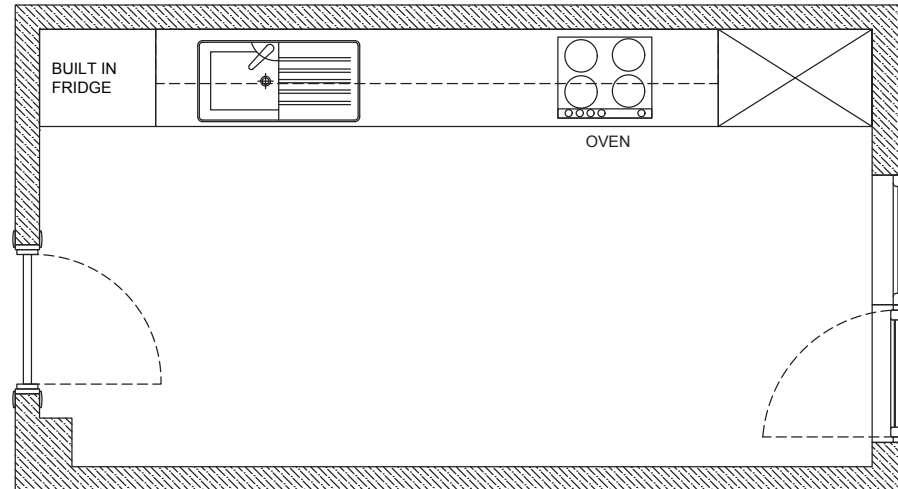
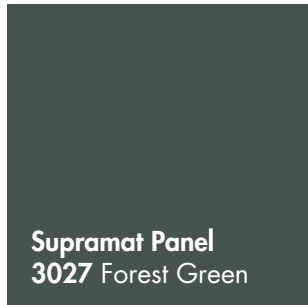
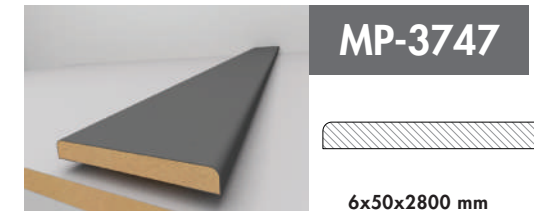

Multi Purpose Profile



8 mm Cabinet Door Profile



-  Lacquer Surface
-  Repairable Micro Scratches
-  Anti-Fingerprint
-  Superior Surface Quality
-  Antibacterial
-  Steam Resistant
-  One-Double Sided Alternatives

*See page 75 for our other color options







One-Wall Kitchen 2

Add dimension to your kitchen with the depth created by the glass doors while feeling peace and comfort with the calmness created by the blue tones.



4 mm Glass Profile

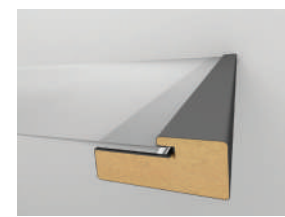

MP-1052

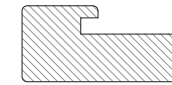

22x47x2800 mm

18 mm Cover Profile



MP-1047



16x24x2800 mm



Anti-Fingerprint



Stain Resistant



Steam Resistant



SMR Technology on Solid Surfaces



High Scratch Resistance



Surface Alternatives



Eco Friendly PET



Antibacterial



One-Double Sided Alternatives

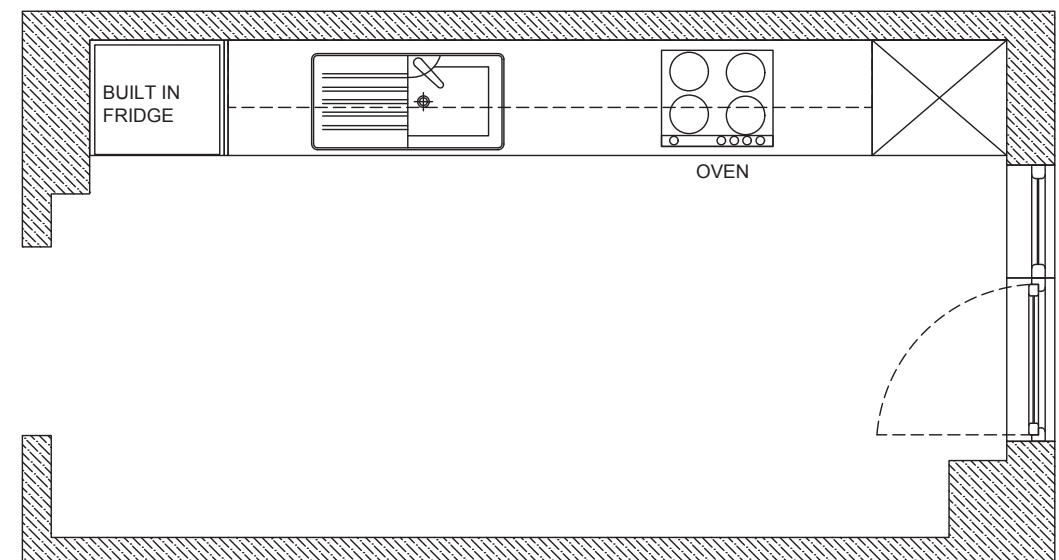
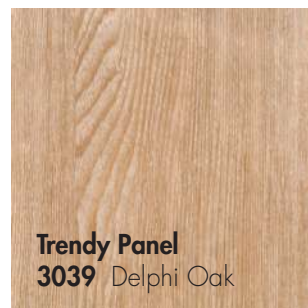
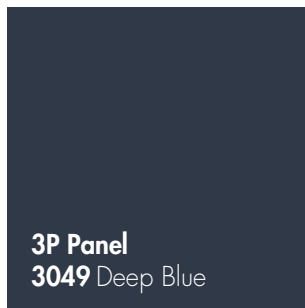

*For other color options see pages 74 (3P) and 76-77 (Trendy)





Parallel Kitchen

Think of parallel kitchen areas in a classic style. Reflect your style with the classic kitchen where light color tones meet country.





Multi Purpose Profile

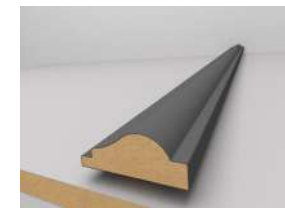

MP-1100

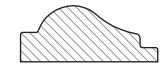

12x30x2800 mm

8mm Cabinet Door Profile

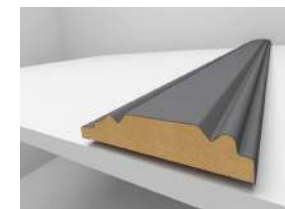

MP-5250



12x60x2800 mm

**AkriLux Panel
398 Super Matt
Light Cream**

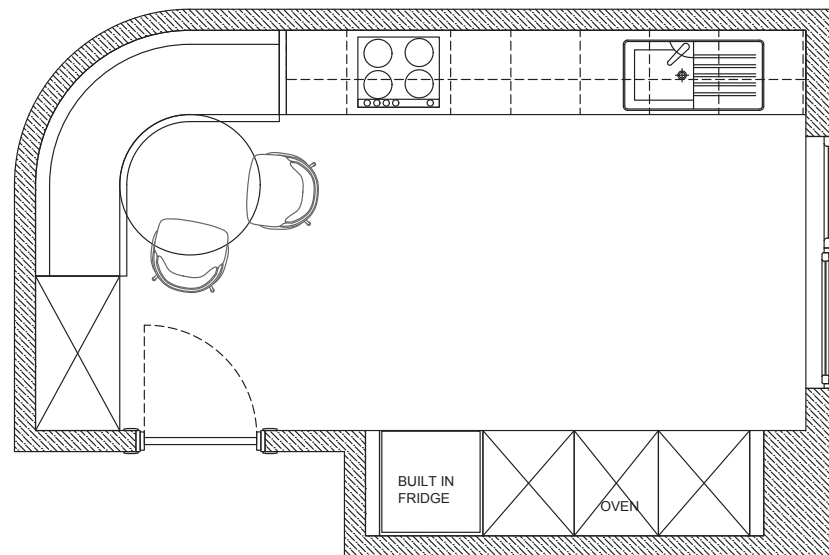

Scratch Resistant



Low Reflectivity on
Matte Surfaces



One-Double Sided
Alternatives



Acrylic Effect on
High Gloss Surfaces



ECO Friendly PET



Steam Resistant

*See page 75 for our other color options







Classic Kitchen Island

Capture elegance with the classic kitchen island, which gives peace with the blue tones in the kitchen cabinets and achieves perfect harmony with the textured surfaces used in the island design.

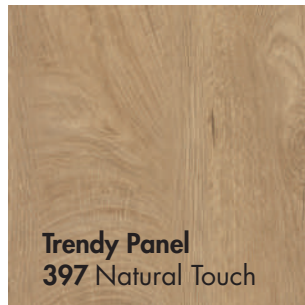
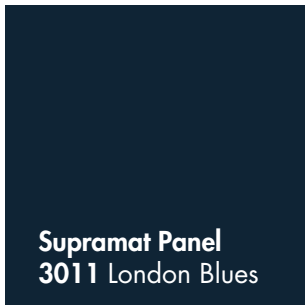

4 mm Glass Profile

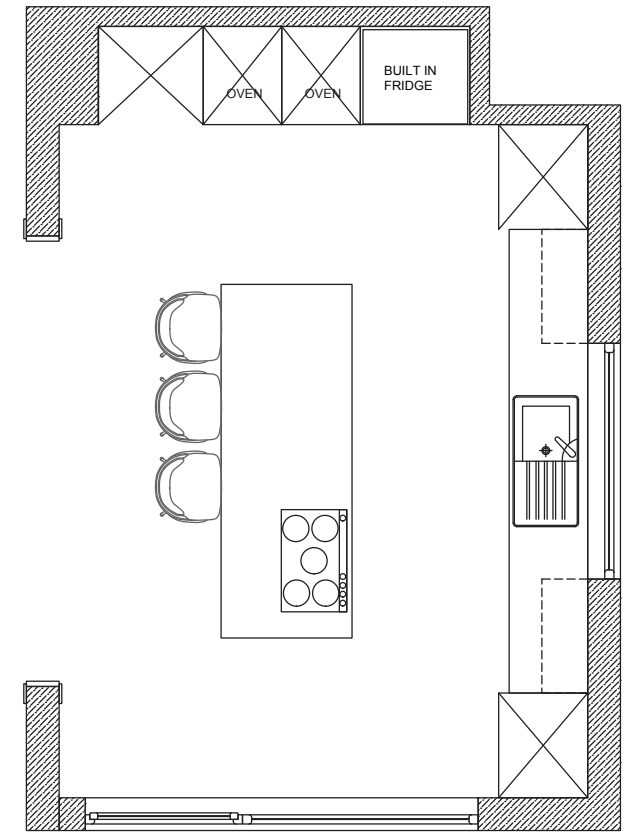
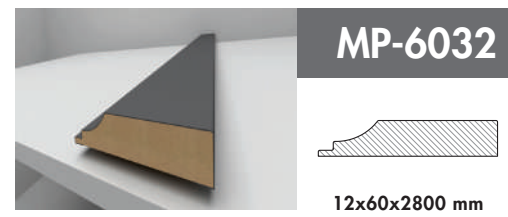
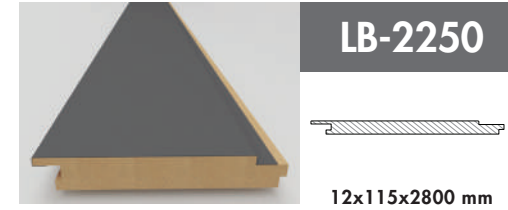
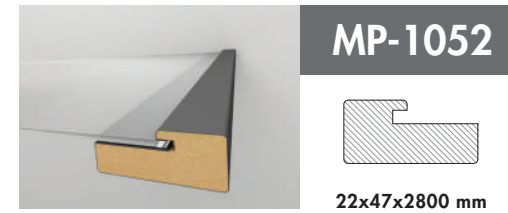

Lacquer Surface



Repairable Micro Scratches



Anti-Fingerprint



Scratch Resistant



Stain Resistant



Trend Colors



Low Reflectivity on Matte Surfaces



Surface Alternatives



Steam Resistant



Superior Surface Quality

*For other color options see pages 74 (3P), 75 (Supramat) and 76-77 (Trendy)







MODERN KITCHEN DESIGNS





One-Wall Kitchen

Modern kitchens, where the modern look meets light tones, creating a calm and spacious atmosphere, also give your kitchen a sophisticated look with their textured covers.



4 mm Glass Profile

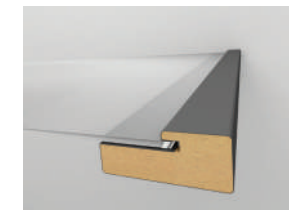

MP-1052

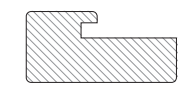

22x47x2800 mm



Anti-Fingerprint



Surface Alternatives



Stain Resistant



Eco Friendly PET



Steam Resistant



Antibacterial



SMR Technology on Solid Surfaces



One-Double Sided Alternatives



High Scratch Resistance

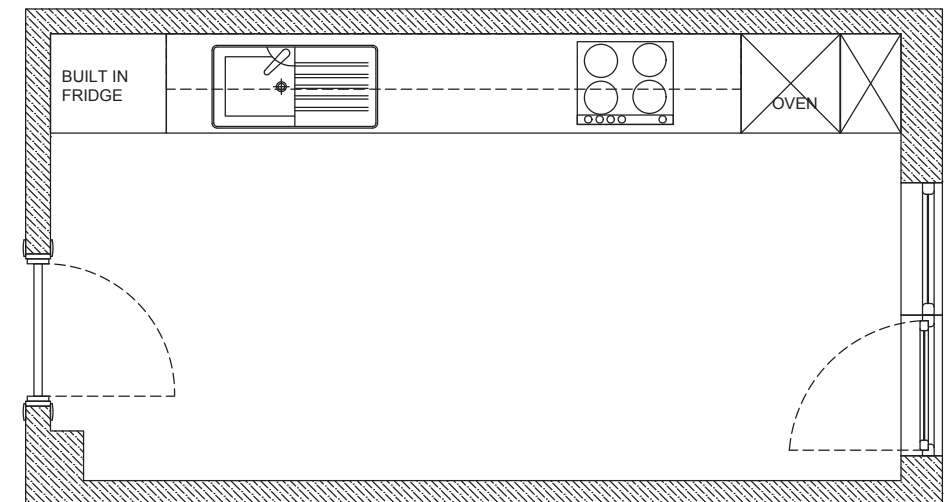
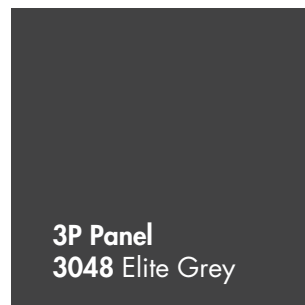

*See page 74 for our other color options







One-Wall Kitchen 2

We are sure that you will achieve excellent results with the kitchen bench, countertops and accessories that you will combine with these colors.

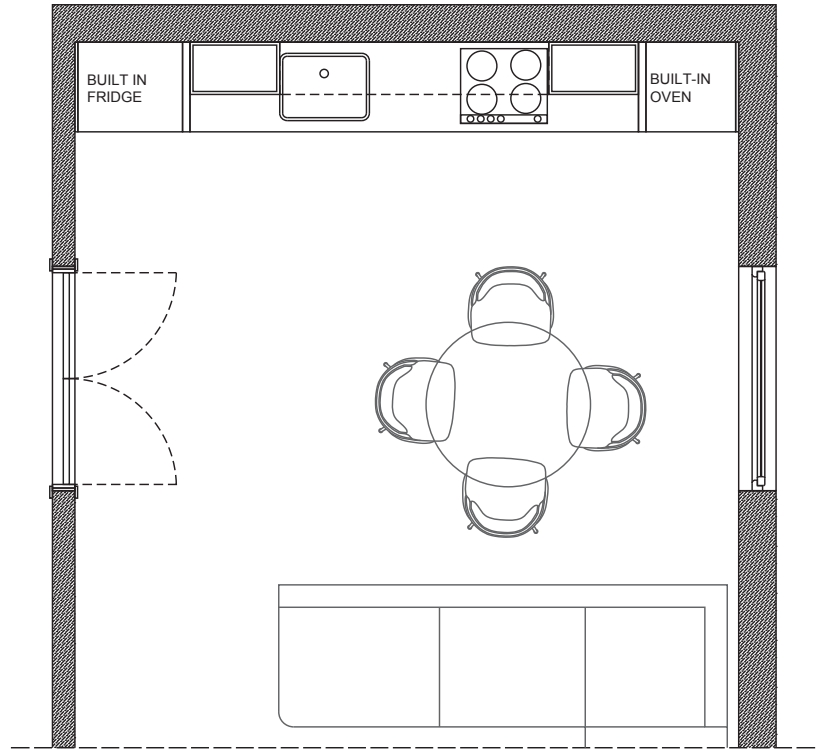
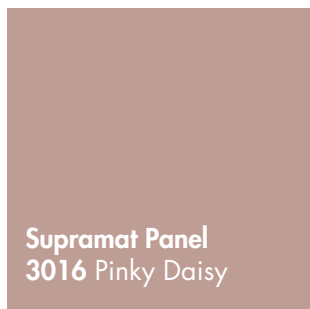

- 
 Lacquer Surface
- 
 Repairable Micro Scratches
- 
 Anti-Fingerprint
- 
 Scratch Resistant
- 
 Steam Resistant
- 
 Antibacterial
- 
 One-Double Sided Alternatives

**See page 75 for our other color options*







L-Shaped Kitchen + Living Area 1

Add a modern touch to your L kitchens that merge with your living spaces with timeless, neutral color options.



Multi Purpose Profile

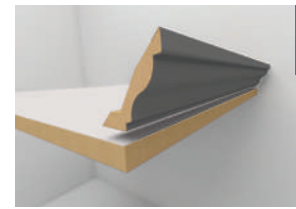

MP-1220

18x80x2800 mm

Wall Profile

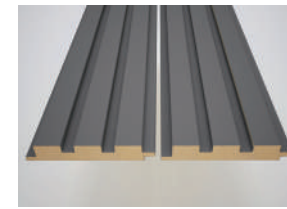

LB-3771

18x121x2800 mm

18 mm Side Closing Profile

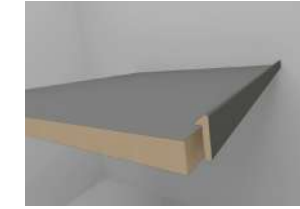

MP-4895

8x24x2800 mm

4 mm Glass Profile

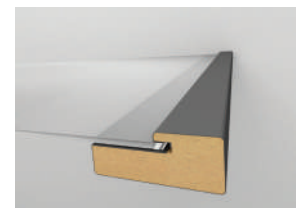

MP-1052

22x47x2800 mm

Corner Radius Profile



MP-1190

35x110x2800 mm

Multi Purpose Profile

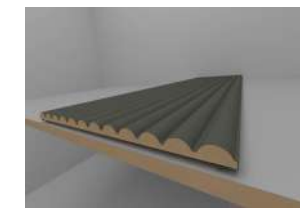

MP-6000

8x184x2800 mm

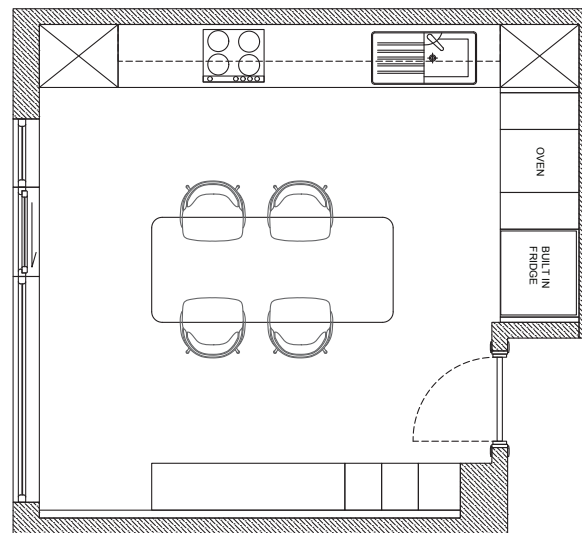
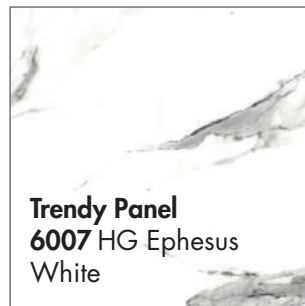
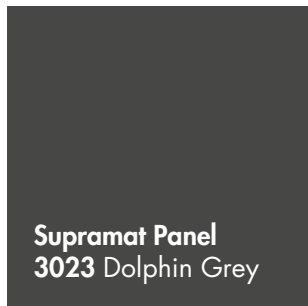

Lacquer Surface



Repairable Micro
Scratches



Scratch Resistant



Anti-Fingerprint



Steam Resistant



Superior Surface
Quality



Acrylic Effect on
High Gloss Surfaces



Low Reflectivity on
Matte Surfaces

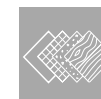

Surface Alternatives



Trend Colors



Antibacterial



One-Double Sided
Alternatives

*For other color options see pages 75 (Supramat), 76-77 (Trendy)



Furniture Profile
MP-1052



Trendy Panel
HG Ephesus White

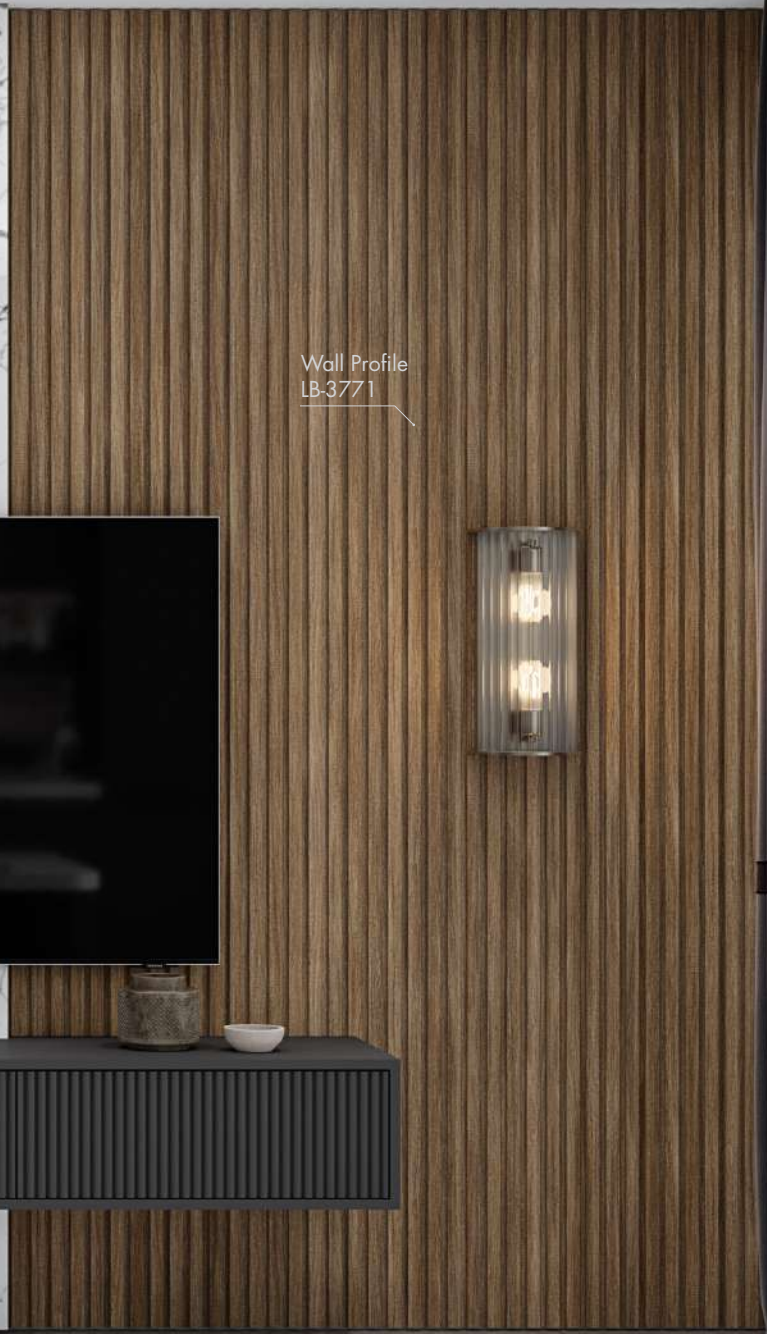

Wall Profile
LB-3771



Furniture Profile
MP-6000





L Shaped Kitchen + Living Area 2

Combine your L kitchens with the elegance of anthracite and dark gray tones and the warmth of wood. Ensure the continuity of textures and colors in kitchen cabinets in your space.

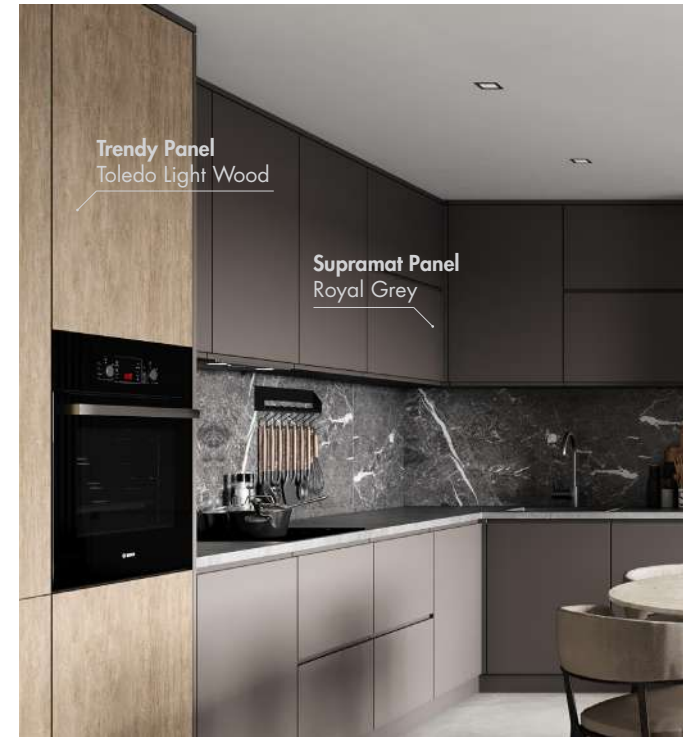

Lacquer Surface



Repairable Micro
Scratches



Anti-Fingerprint



Scratch Resistant



Steam Resistant



Superior Surface
Quality



Surface
Alternatives



Trend Colors

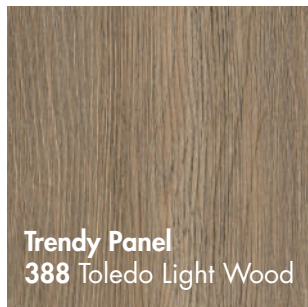

Wall Profile



LB-3771

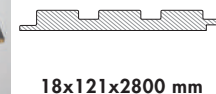

18x121x2800 mm

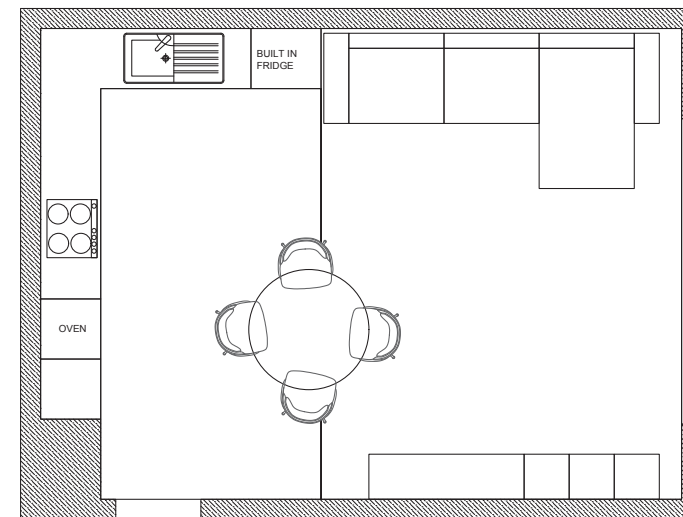

Antibacterial



One-Double Sided
Alternatives

*For other color options see pages 75 (Supramat), 76-77 (Trendy)







L - Shaped Kitchen

It increases the feeling of depth in your L kitchens with its continuity in the same color and order, and adds freshness to your kitchen with its light tones.



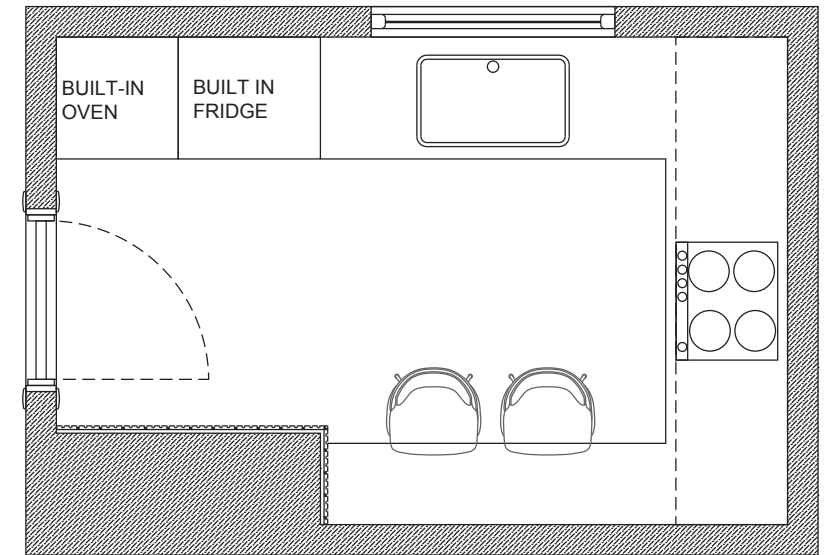
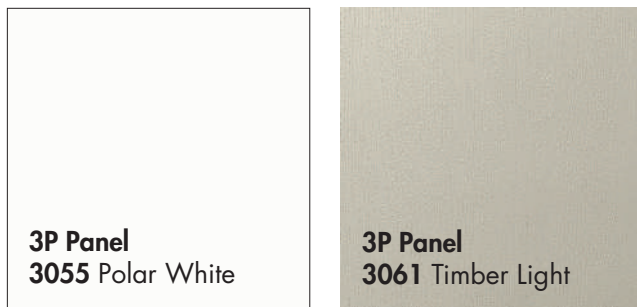

-  Anti-Fingerprint
 -  Stain Resistant
 -  Steam Resistant
 -  SMR Technology on Solid Surfaces
 -  High Scratch Resistance
-  Surface Alternatives
 -  Eco Friendly PET
 -  Antibacterial
 -  One-Double Sided Alternatives

*See page 74 for our other color options







Parallel Kitchen

Add a modern flair to parallel kitchen areas. Add peace to your kitchen with the freshness and simplicity of green tones.





Wall Profile

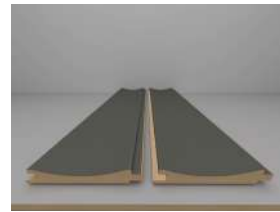

LB-3821



18x128x2800 mm

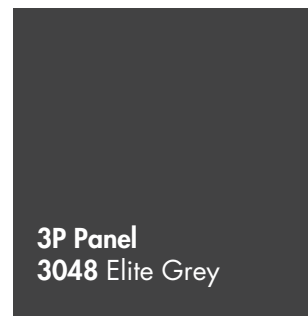
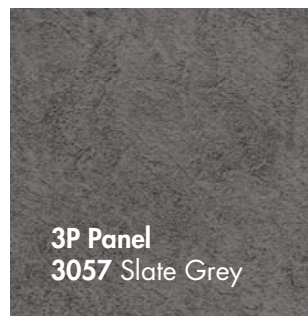
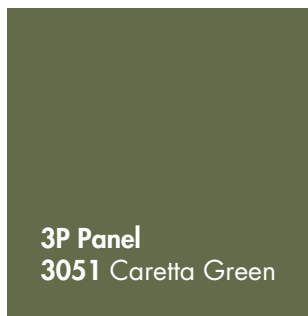
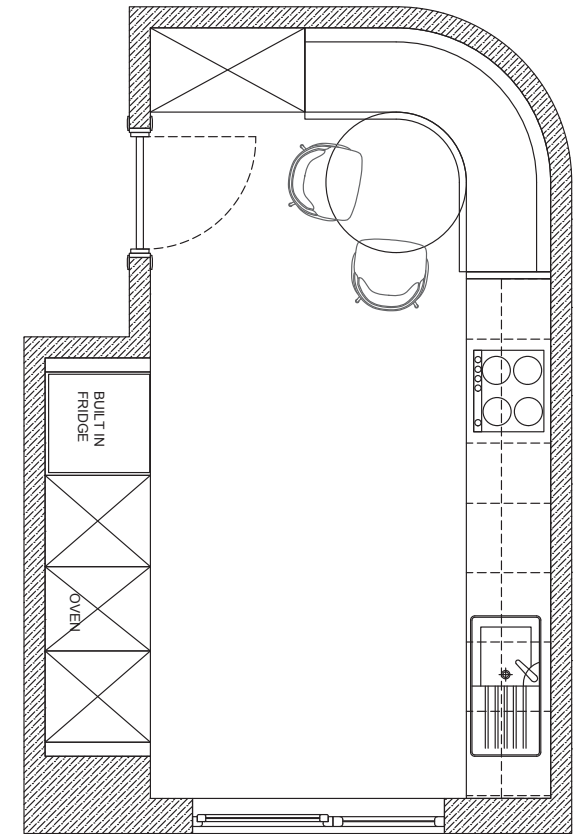
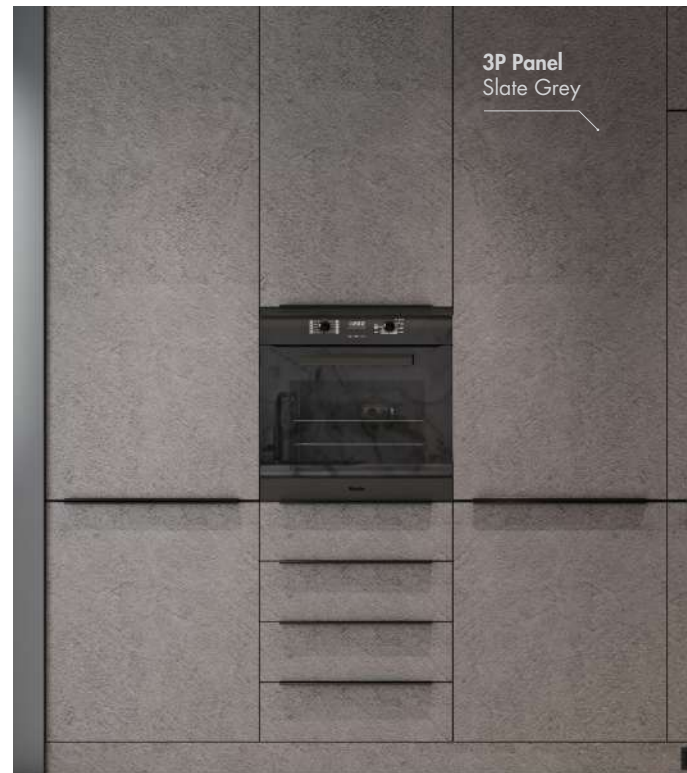

Anti-Fingerprint



Stain Resistant



Steam Resistant



SMR Technology on Solid Surfaces



High Scratch Resistance

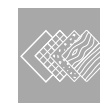

Surface Alternatives



Eco Friendly PET



Antibacterial



One-Double Sided Alternatives

*See page 74 for our other color options







Island Kitchen 1

In the same modern kitchen, we used light-coloured HG and combined the contrast with dark contours and countertops. The choice is yours. Light high gloss or dark matte?

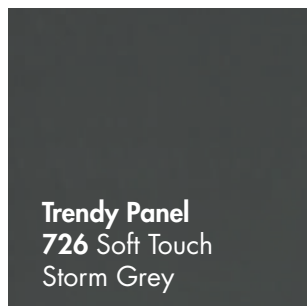
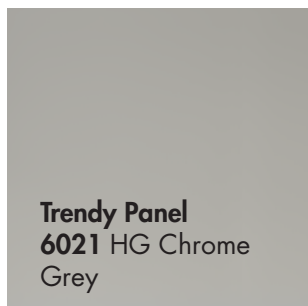
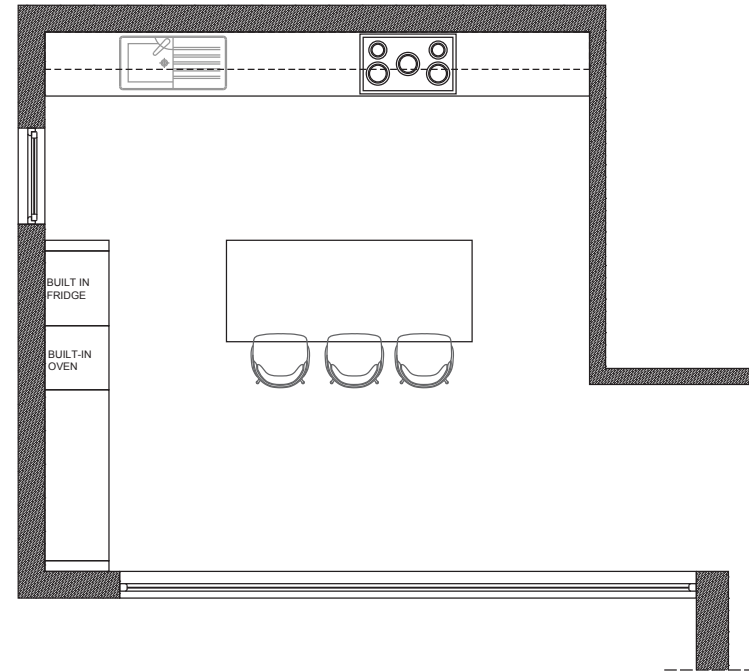

Acrylic Effect on
High Gloss Surfaces



Scratch Resistant



Low Reflectivity on
Matte Surfaces



Steam Resistant



Suitable for
Food Contact



Superior Surface
Quality



Trend Colors

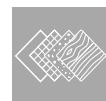

Surface Alternatives

*For other color options see pages 76-77 (Trendy)





Island Kitchen 2

Don't stick to one color in small spaces.
When you combine different color tone transitions properly, it is possible to achieve the desired effects in your spaces.



Trendy Panel
Super Matt Toros White Marble



- 
Lacquer Surface
- 
Repairable Micro Scratches
- 
Anti-Fingerprint
- 
Stain Resistant
- 
Scratch Resistant
- 
Steam Resistant
- 
Superior Surface Quality
- 
Trend Colors
- 
Low Reflectivity on Matte Surfaces
- 
Surface Alternatives
- 
Acrylic Effect on High Gloss Surfaces

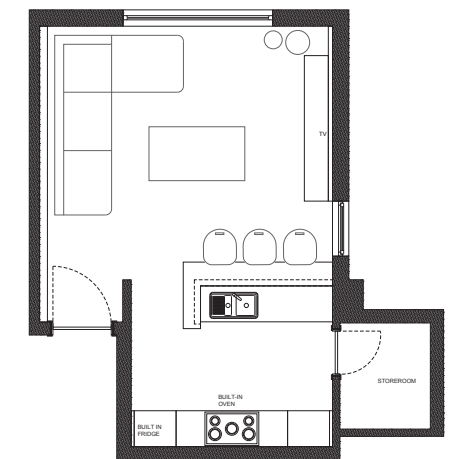
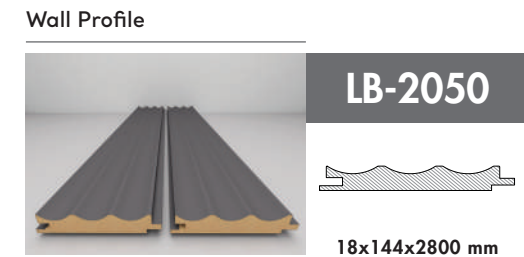
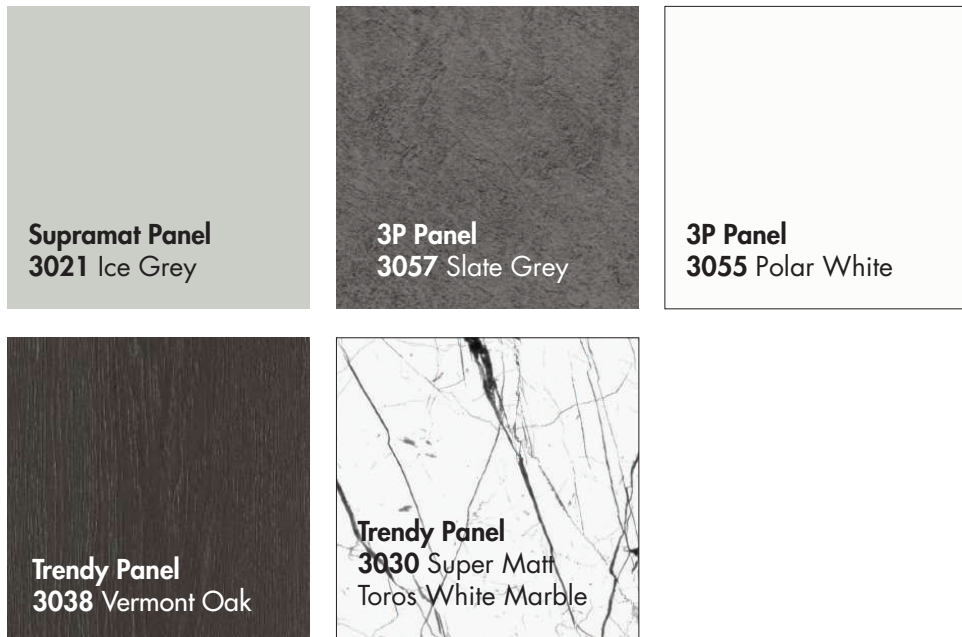

*For other color options see pages 74 (3P), 75 (Supramat) and 76-77 (Trendy)



In small spaces, especially in places where the living room and kitchen are one, you cannot think of the kitchen design very differently from the living room concept. If you make a difference with color and tonal transitions between textures, your space will appear larger than it is.







Island Kitchen 3

If you have a kitchen with a large window that invites daylight in all day, do not avoid using dark colors. Contouring the black color with gray tones in the modern island kitchen will add a different elegant atmosphere to your kitchen.

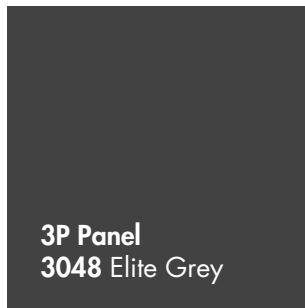
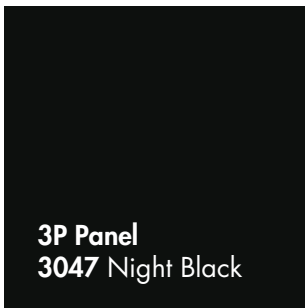
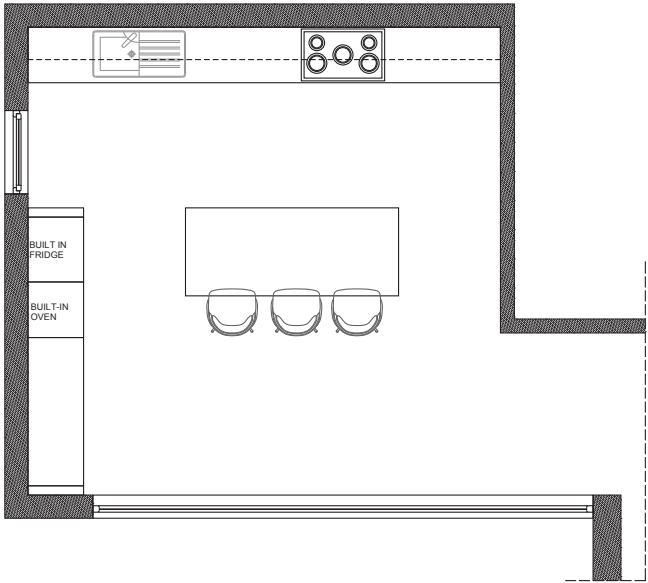

Anti-Fingerprint



Stain Resistant



Steam Resistant



SMR Technology on
Solid Surfaces



High Scratch Resistance



Eco Friendly PET



Antibacterial



Surface Alternatives



One-Double Sided
Alternatives

*See page 74 for our other color options







Island Kitchen 4

Create a stylish and modern atmosphere in your kitchen by harmonizing the calmness of light tones and the warmth of brown tones.



Wall Profile

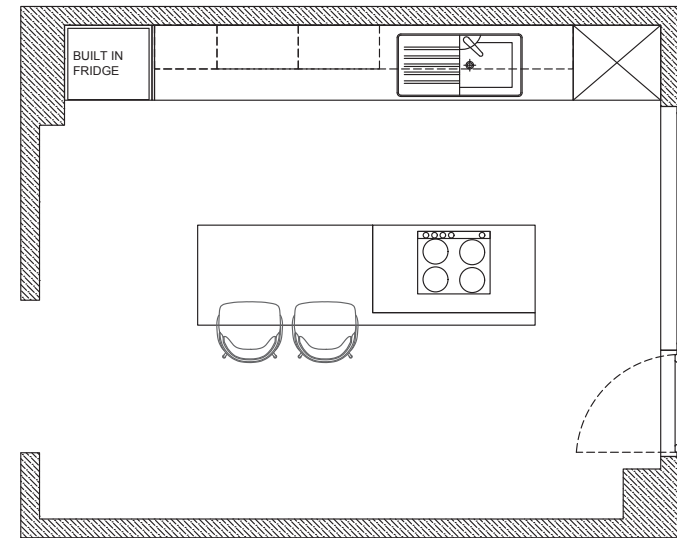
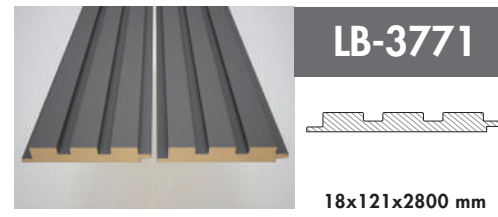

You can use AGT wall profiles not only on the wall but also on table or counter legs or on the ceiling, just like in this kitchen design.

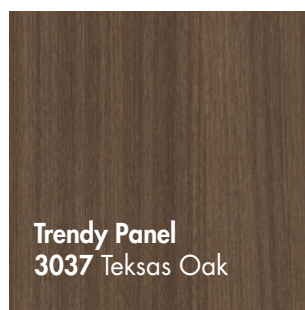

Lacquer Surface



Antibacterial



Scratch Resistant



Anti-Fingerprint



Repairable Micro Scratches



One-Double Sided Alternatives



Steam Resistant



Trend Colors



Surface Alternatives



Superior Surface Quality

*For other color options see pages 75 (Supramat), 76-77 (Trendy)







U-Shaped Kitchen

You can take your furniture designs to a whole new dimension with the gold or silver metal effect in the AGT Trendy collection.

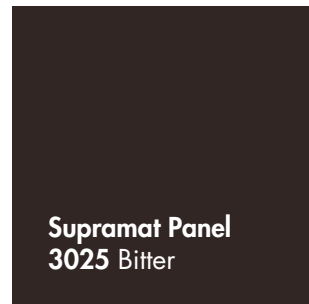
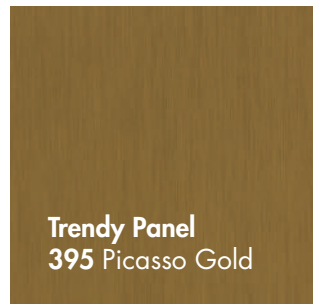
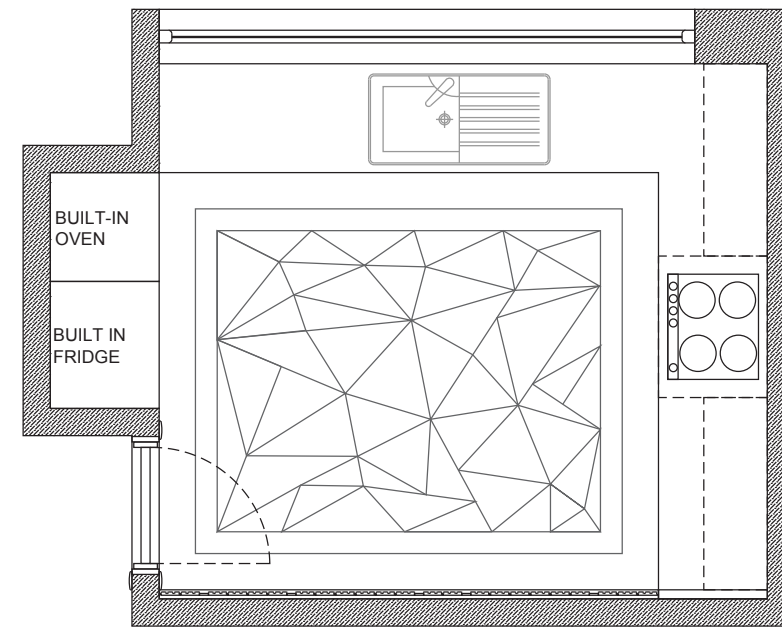

Lacquer Surface



Antibacterial



Scratch Resistant



Anti-Fingerprint



Repairable Micro
Scratches



One-Double Sided
Alternatives



Steam Resistant



Trend Colors

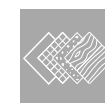

Surface Alternatives



Superior Surface
Quality

**For other color options see pages 75 (Supramat), 76-77 (Trendy)*



3P PREMIUM PET PANEL COLLECTION DECORS

SURFACES

SOLID SURFACES

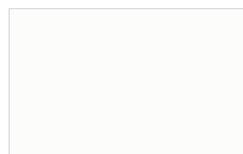

3055 Polar White



3054 Latte Cream



3053 Vintage Beige



3052 Comfort Grey



3051 Caretta Green



3050 Leaf Green



3049 Deep Blue



3048 Elite Grey

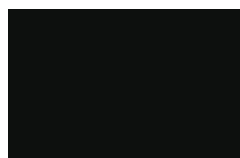

3047 Night Black

TEXTURED SURFACES

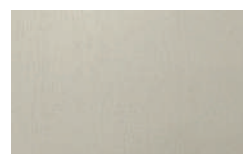

3061 Timber Light



3059 Textile Light



3060 Textile Vison

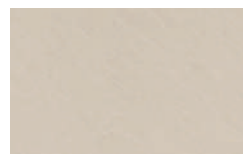

3056 Slate Cream

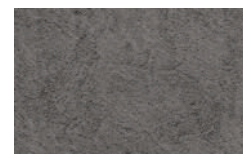

3057 Slate Grey

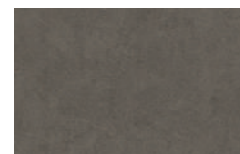

3058 Slate Coffee



3064 Croco Cream



3062 Croco Blue

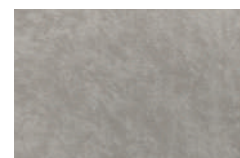

3063 Croco Grey

There are ABS and PVC Edge Bands that are perfectly compatible with all colors.



3066 Limba Light Grey

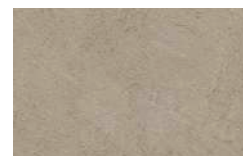

3069 Slate Beige

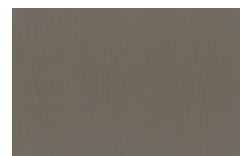

3071 Timber Grey

SUPRAMAT DECORS

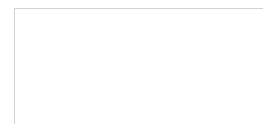

3012 Snow White

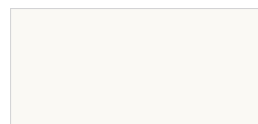

3028 Pearl White

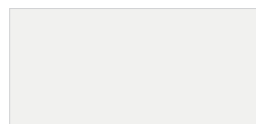

3018 Moonlight



3019 Sahara Cream



3013 Breeze Beige



3020 Safari Grey



3016 Pinky Daisy



3015 Macaron Green



3021 Ice Grey



3017 Timeless Grey



3027 Forest Green



3029 Glamorous Pasific



3011 London Blues



3026 Rustic Red



3025 Bitter



3014 Cloudy Grey



3024 Pebble Grey



3022 Royal Grey



3023 Dolphin Grey



3010 Pearl Black

AKRILUX DECORS

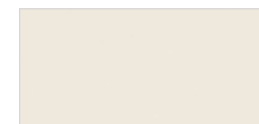

398 Super Matt Light Cream

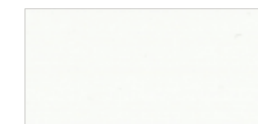

3001 Super Matt Light Grey



399 Super Matt Pebble Grey



3002 Super Matt Dark Grey

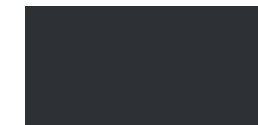

3003 Super Matt Night Blue



3004 Super Matt Black



6009 HG Luxe White

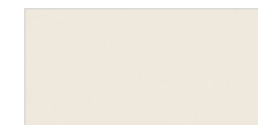

6011 HG Light Cream

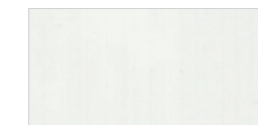

6013 HG Light Grey



6016 HG Onyx Grey



6012 HG Pebble Grey

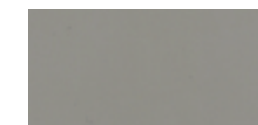

6015 HG Diamond Grey



6014 HG Grey



6010 HG Luxe Black

Colors may vary in digital and printed catalogs. Please compare with the actual products in the sales points.

TRENDY PANEL DECORS

1.GROUP



601 HG White

2.GROUP



390 Matt Stone Grey

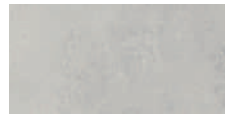

391 Matt Stone Beige



393 Matt Stone Art

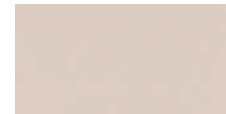

605 HG Cream

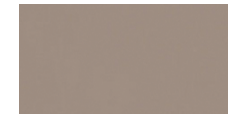

623 HG Vison

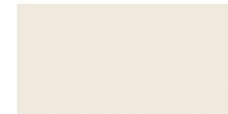

647 HG Bianco



723 Soft Touch Black



726 Soft Touch Storm Grey



728 Soft Touch Stone Grey



729 Soft Touch New Grey



730 Soft Touch Cream



732 Soft Touch Vison

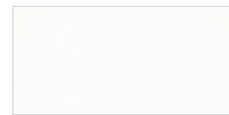

734 Soft Touch White



735 Soft Touch Relax Green



736 Soft Touch Ocean Blue



739 Soft Touch Yellow



878 HG New Vison



3039 Delphi Oak



3041 Peru Oak



3042 Silver Oak



6002 HG New Black



6008 HG Deluxe Grey



6017 HG Cool Grey



6021 HG Chrome Grey



6022 HG Anthracite

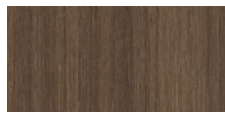

3037 Texas Oak

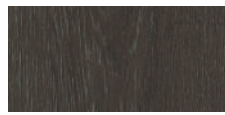

3038 Vermont Oak



3040 Orlando Oak



3043 Alaska Oak

3.GROUP



627 HG Milano Walnut



3030 Super Matt Toros White Marble

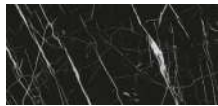

3031 Super Matt Toros Black Marble



6018 HG Toros White Marble

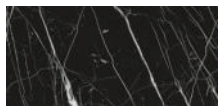

6019 HG Toros Black Marble

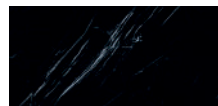

6006 HG Ephesus Black Marble



6007 HG Ephesus White



6020 HG Trend Grey

4.GROUP

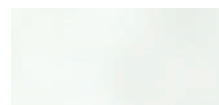

383 Matt Cashmere White



384 Matt Cashmere Gold

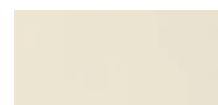

385 Matt Cashmere Cream

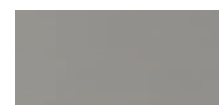

387 Matt Cashmere Grey

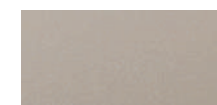

678 HG Galaxy Cream



397 Natural Touch Oak

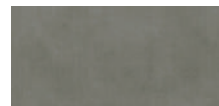

3032 Matt Stone Loft



6003 HG Porte Silver



608 HG Metallic Anthracite



640 HG Galaxy Honey Mist



670 HG Galaxy White



675 HG Line Pearl



394 Picasso Inox



395 Picasso Gold

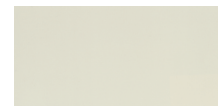

699 HG Metallic White



737 Soft Touch Siena Wood



3006 Matt Galaxy White



3033 Super Matt Galaxy Grey

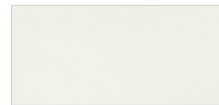

6004 HG Porte Pearl White



388 Toledo Light Wood

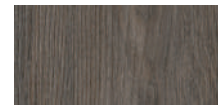

389 Toledo Dark Wood

MOST TRENDING COMBINATIONS

Trendy
6008 HG Deluxe Grey

Trendy
3042 Silver Oak

Trendy
6017 HG Cool Grey

3P
3062 Croco Blue

3P
3049 Deep Blue

3P
3063 Croco Grey

3P
3053 Vintage Beige

3P
3064 Croco Cream

Supramat
3016 Pinky Daisy

Supramat
3026 Rustic Red

Trendy
728 Soft Touch Stone Grey

Trendy
3037 Texas Oak

Supramat
3019 Sahara Cream

Akrilux
6014 HG Grey

Akrilux
6013 HG Light Grey

Akrilux
6012 HG Pebble Grey

Supramat
3011 London Blues

Trendy
397 Natural Touch Oak

3P
3057 Slate Grey





AGT

WOOD
MEETS
TECHNOLOGY

agt.com.tr

[f](#) [in](#) [p](#) [i](#) [You Tube](#) /agtworld